

Podcast

Forecast

Elegant. Simple. Functional.

When designing our Podcast line, we interviewed our customers to find out what they really need. First up was acoustics. We include removable sound panels at every position to combat noise. With many shows now incorporating a video component, clean tabletops are a must. We hid the cable passthrough in plain sight by making them aesthetically pleasing. Same goes for undercounter cable management. For quality of life, we added convenience charging and easy mounting for mic arms. Longevity was also a concern, so they all come with our standard lifetime warranty. Finally, they need to look good, so we offer customizable finishes. After all, there is no reason that your podcast table shouldn't be as original as your content.



Removable
Acoustic Inlays



Elegant Design Options



Discreet Cable
Passthroughs



Under Counter
Cable Management



Flexible Mic Arm
Placement

Conveniently Placed
Power Outlets



Lifetime Warranty



Upgradable Finish
Options

Podcast

GP-S

SMALL 3 PERSON PODCAST TABLE

This small "guitar pick" shaped desk is perfect for 3 person shows, a host with 2 guests, or 2 people with a video setup. It comes standard with sound panel inserts and pre-drilled 7/8" holes for through-mount mic arms at each position, integrated convenience power, and undercounter cable management. It can be equipped with an optional central base cabinet.

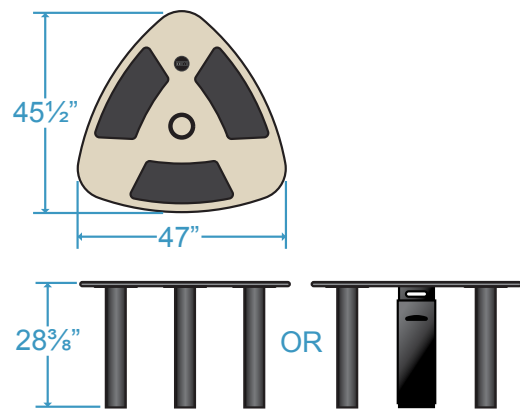
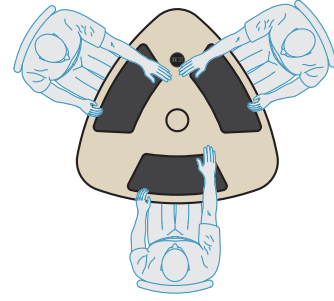

Shown with
Optional Center
Base Cabinet



Convenience
Power

Simple, Clean
Cable Passthrough

(3) Through Holes
for Mic Arms

Removable
Acoustic Inlays

Plenty of Places to
Hide Your Cables

Available with or without
Central Base Cabinet

GP-L

LARGE 3 PERSON PODCAST TABLE

This large "guitar pick" shaped desk is perfect for 3 person shows, a host with 2 guests, or 2 people with a video setup. It comes standard with sound panel inserts for each position, integrated rails for compatible mic arms, and convenience power at each position. It also includes a central cable base, removable side panels and 8 outlet PDU for easy wiring.

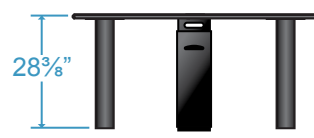
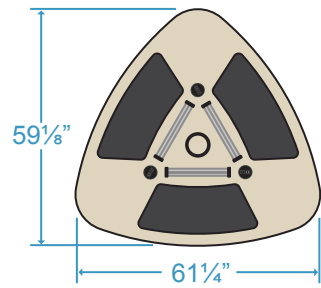
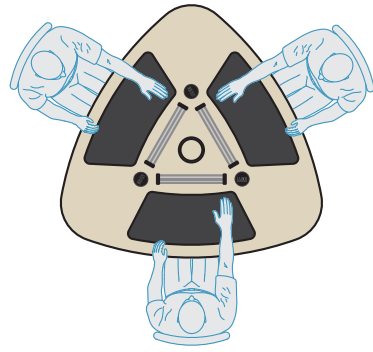

FS-S

SMALL 3 PERSON PODCAST TABLE

This small "fidget spinner" shaped desk is perfect for 3 person shows, a host with 2 guests, or 2 people with a video setup. It comes standard with sound panel inserts for each position, integrated rails for compatible mic arms, and convenience power at each position. It also includes a central cable base, removable side panels and 8 outlet PDU for easy wiring.

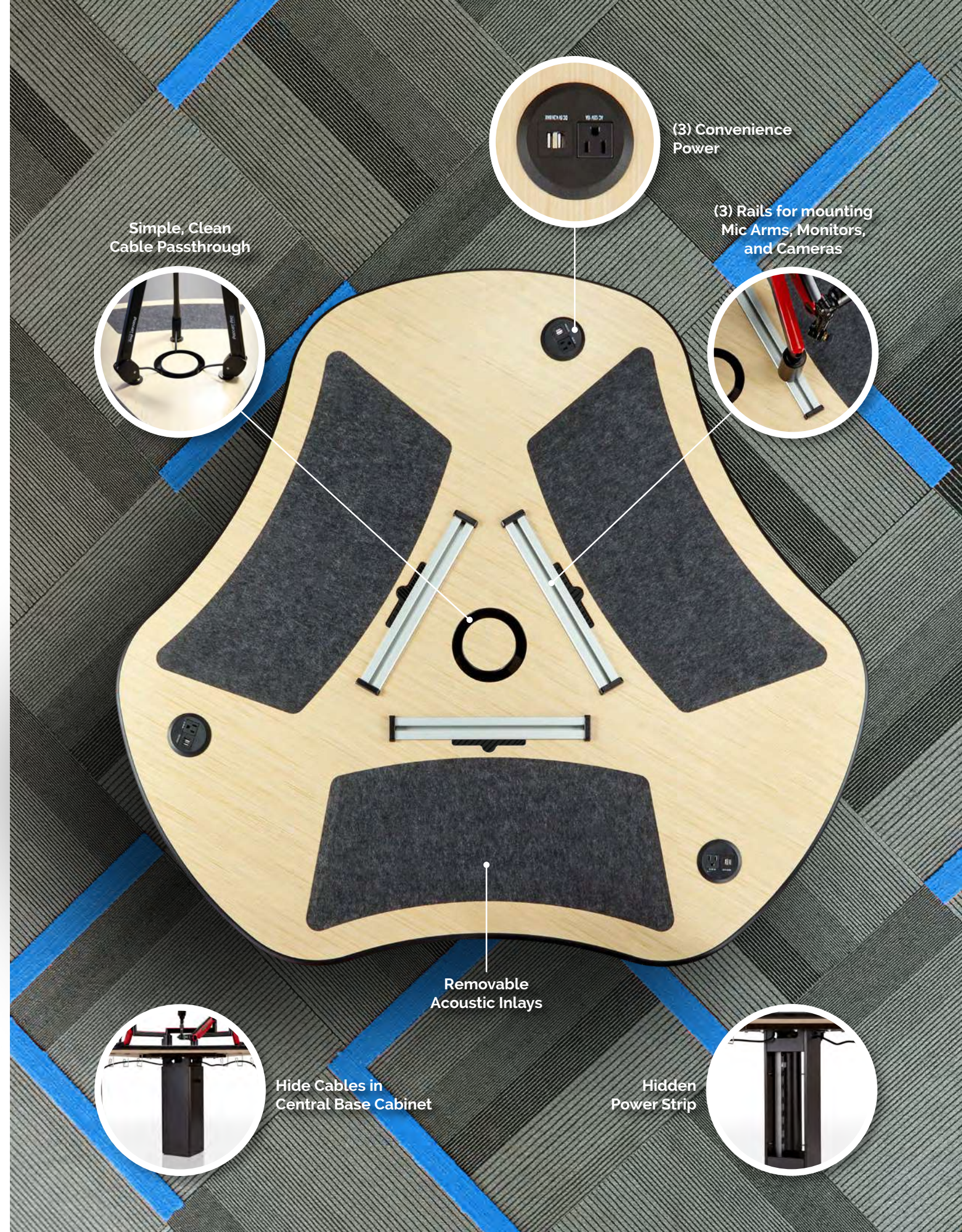
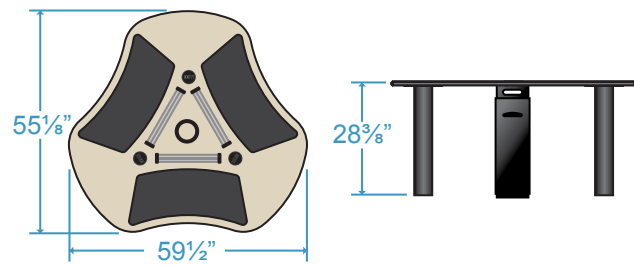
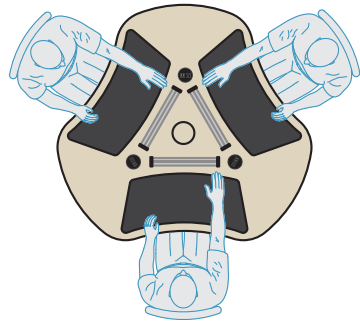

CL-S

MINI 4 PERSON PODCAST TABLE

This mini "clover leaf" shaped podcast desk is perfect for Podcasts on the go. It's small form factor and easy set up make it ideal for small home studios or traveling podcasts. It comes standard with sound panel inserts and pre-drilled 7/8" holed for through-mount mic arms at each position, integrated convenience power and undercounter cable management.

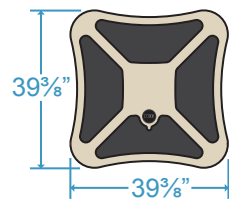
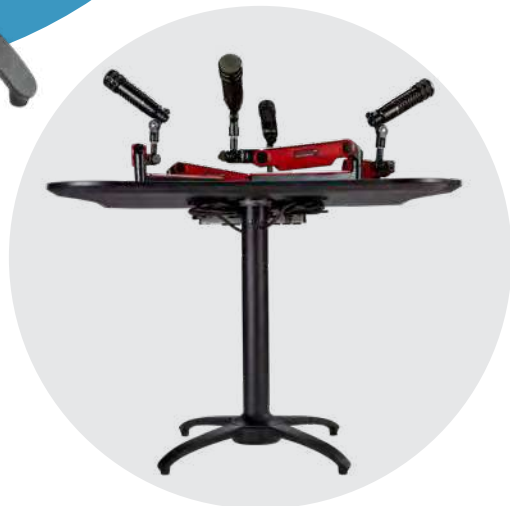
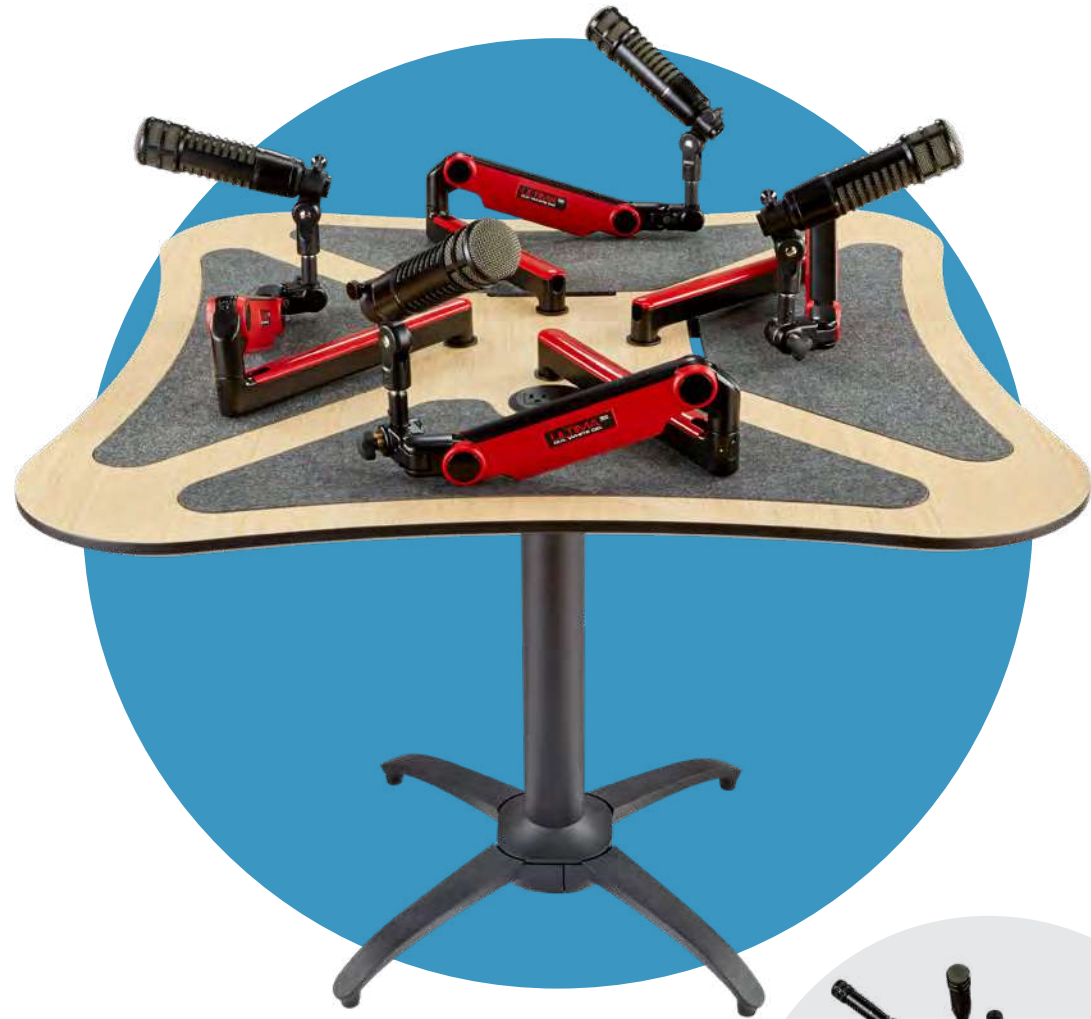
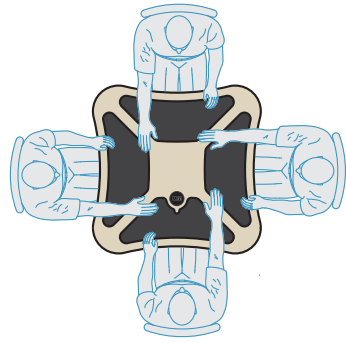

Cable Passthrough Options



Removable Acoustic Inlays



(4) Through Holes for Mic Arms



Plenty of Places to Hide Your Cables



Convenience Power



CL-L

LARGE 4 PERSON PODCAST TABLE

This large "clover leaf" shaped desk is perfect for 4 person shows, a host with 3 guests, or 3 people with a video setup. It comes standard with sound panel inserts for each position, integrated rails for compatible mic arms, and convenience power. It also includes a central cable base, removable side panels and integrated PDU for easy wiring.

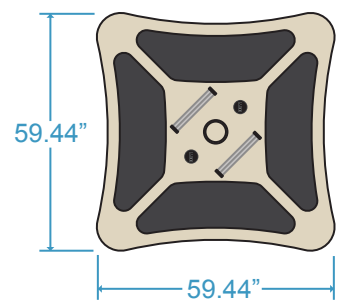
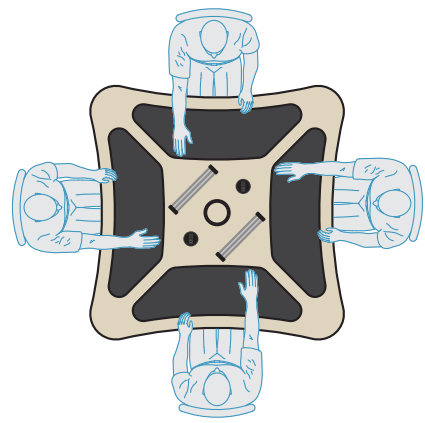

Convenience Power

Removable Acoustic Inlays

(2) Rails for mounting Mic Arms, Monitors, and Cameras

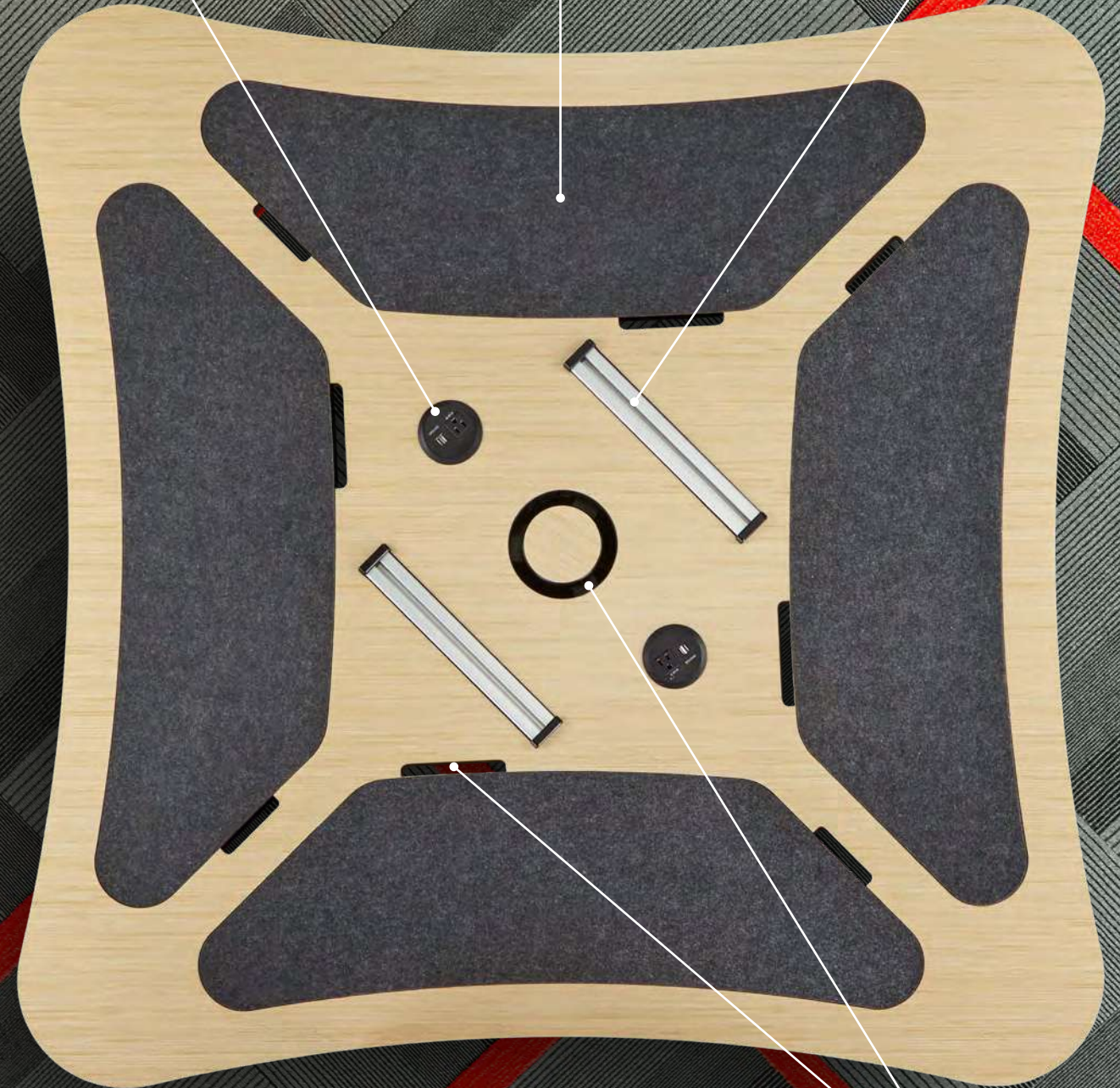

Central Base Cabinet with Plenty of Room for All Your Cables

Simple, Clean Cable Passthrough



AH-S

SMALL 5 PERSON PODCAST TABLE

This small "arrowhead" shaped podcast desk is designed for live video. Capable of multiple seating arrangements including 1 host and 4 guests or a host and 2 guests only on one side. The size and shape allows you to get the camera framing you need regardless of your seating configuration. It includes integrated sound panels and convenience power for each position along with Rails for compatible mic arms. All of this is supported by the ARC base with integrated power 4 RU of vertical mounted rack rails and removable sound panel sides.

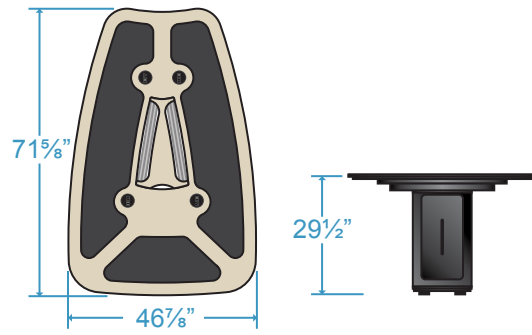
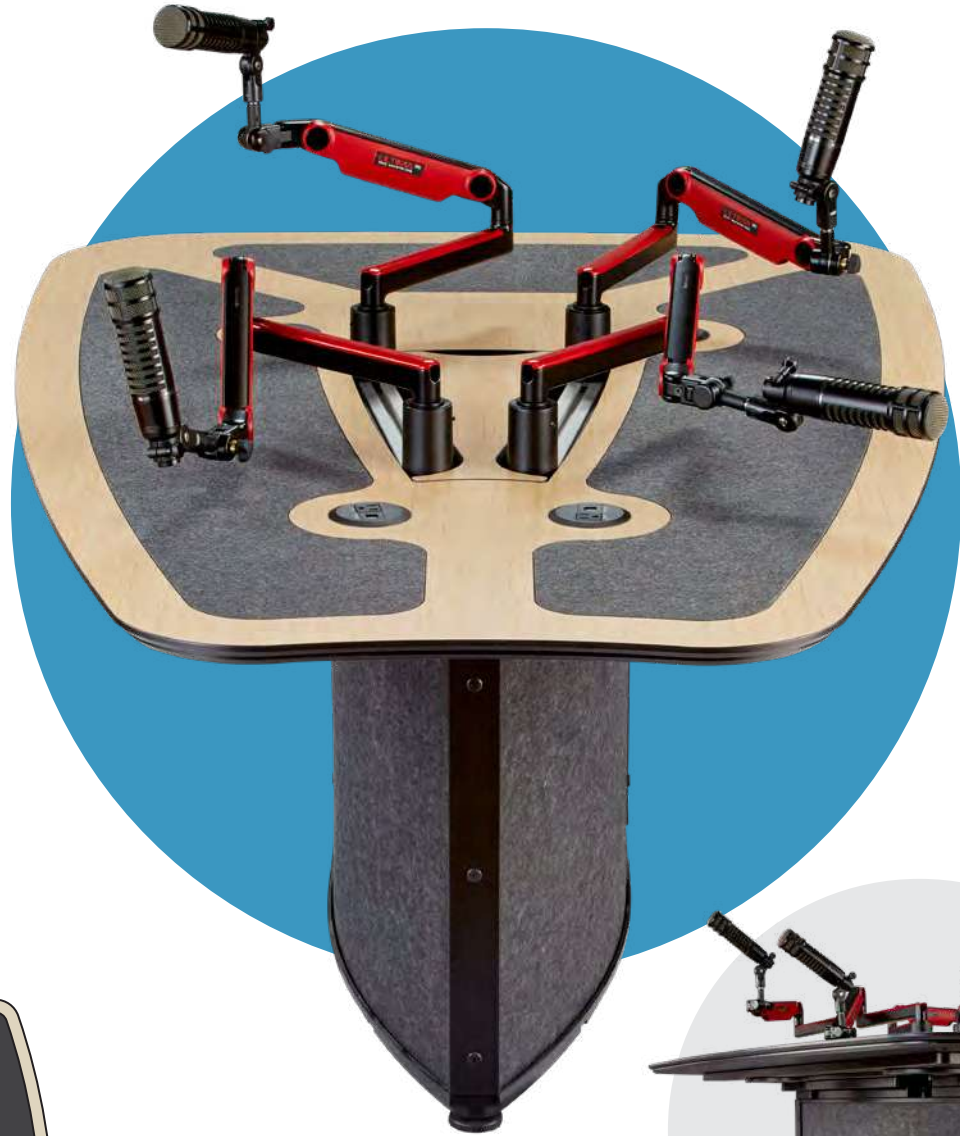
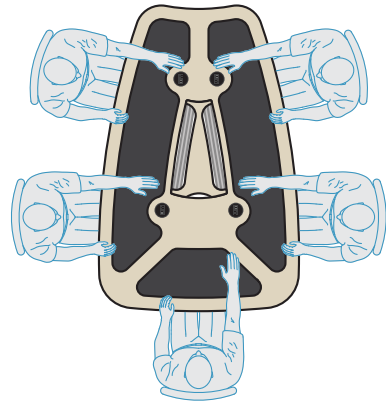

Convenience Power



(2) Rails for mounting Mic Arms, Monitors, and Cameras

Removable Acoustic Inlays



ARC base with removable side panels



Simple, Clean Cable Passthrough

AH-L

LARGE 7 PERSON PODCAST TABLE

This large "arrowhead" shaped podcast desk offers all the same features as our small version just simply designed for a larger cast. It offers a larger countertop as well as a larger ARC base for even more equipment storage.

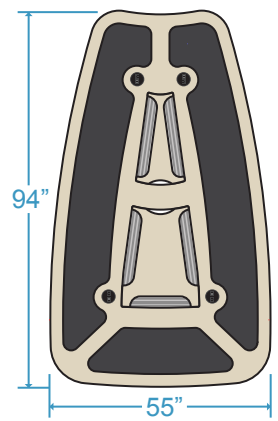
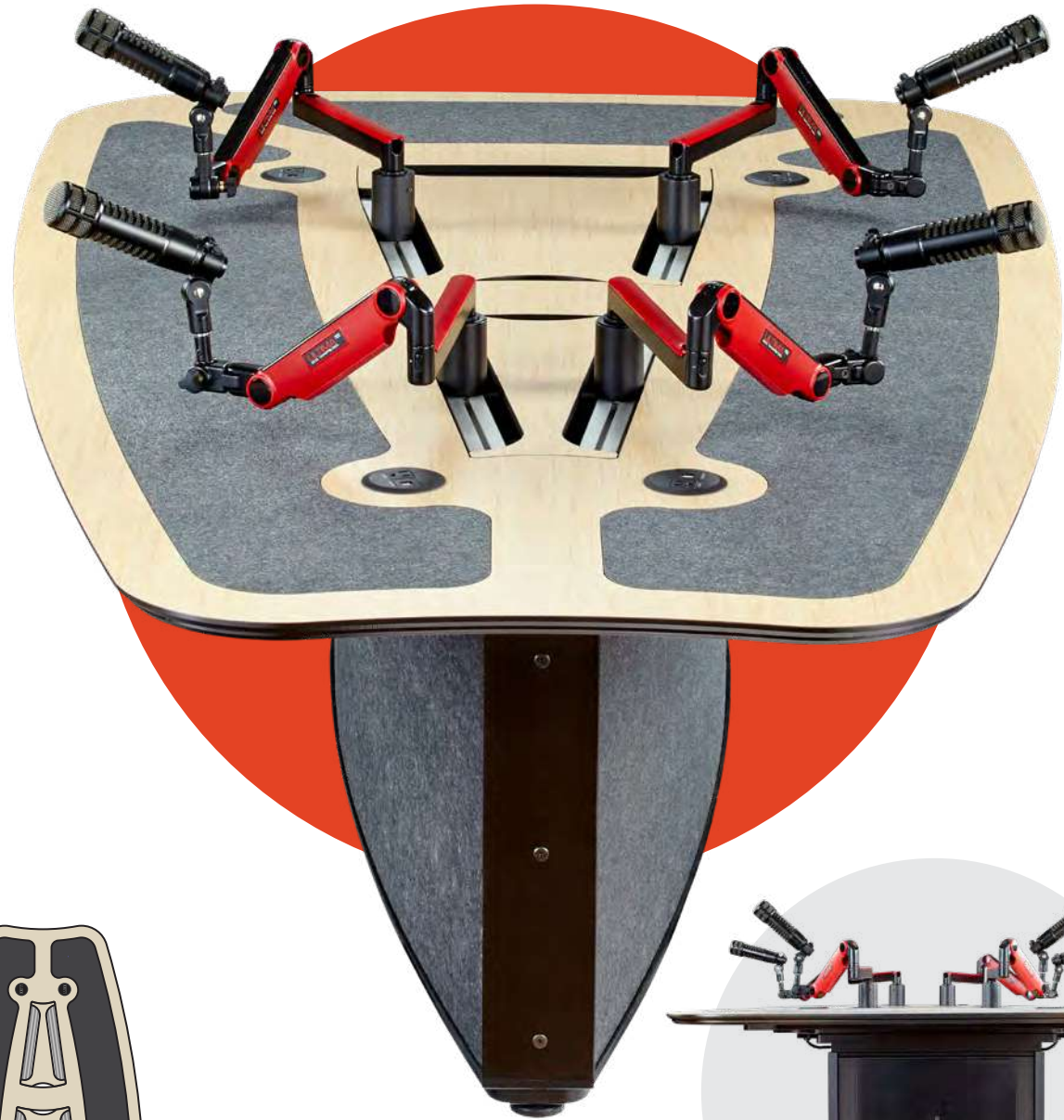
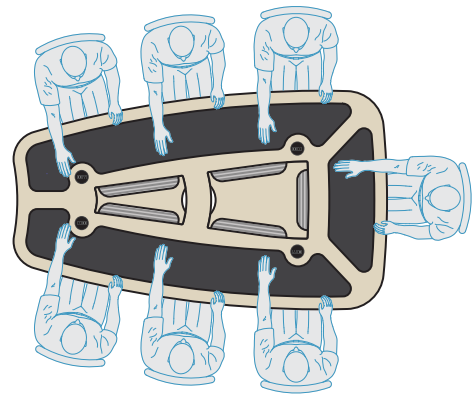

Convenience Power



(4) Rails for mounting Mic Arms, Monitors, and Cameras

Removable Acoustic Inlays



Simple, Clean Cable Passthrough



ARC base with removable rear door

SR-S

SMALL 4 PERSON PODCAST TABLE

This small "stingray" shaped podcast desk is designed with a large host space and 3 guest positions. Mic arms are mounted to a central rail which can also support monitor arms for the host. It comes standard with a Sit Stand base for height adjustment on the fly. It can be configured with an optional 2, 3, or 4 RU removable rack turret.

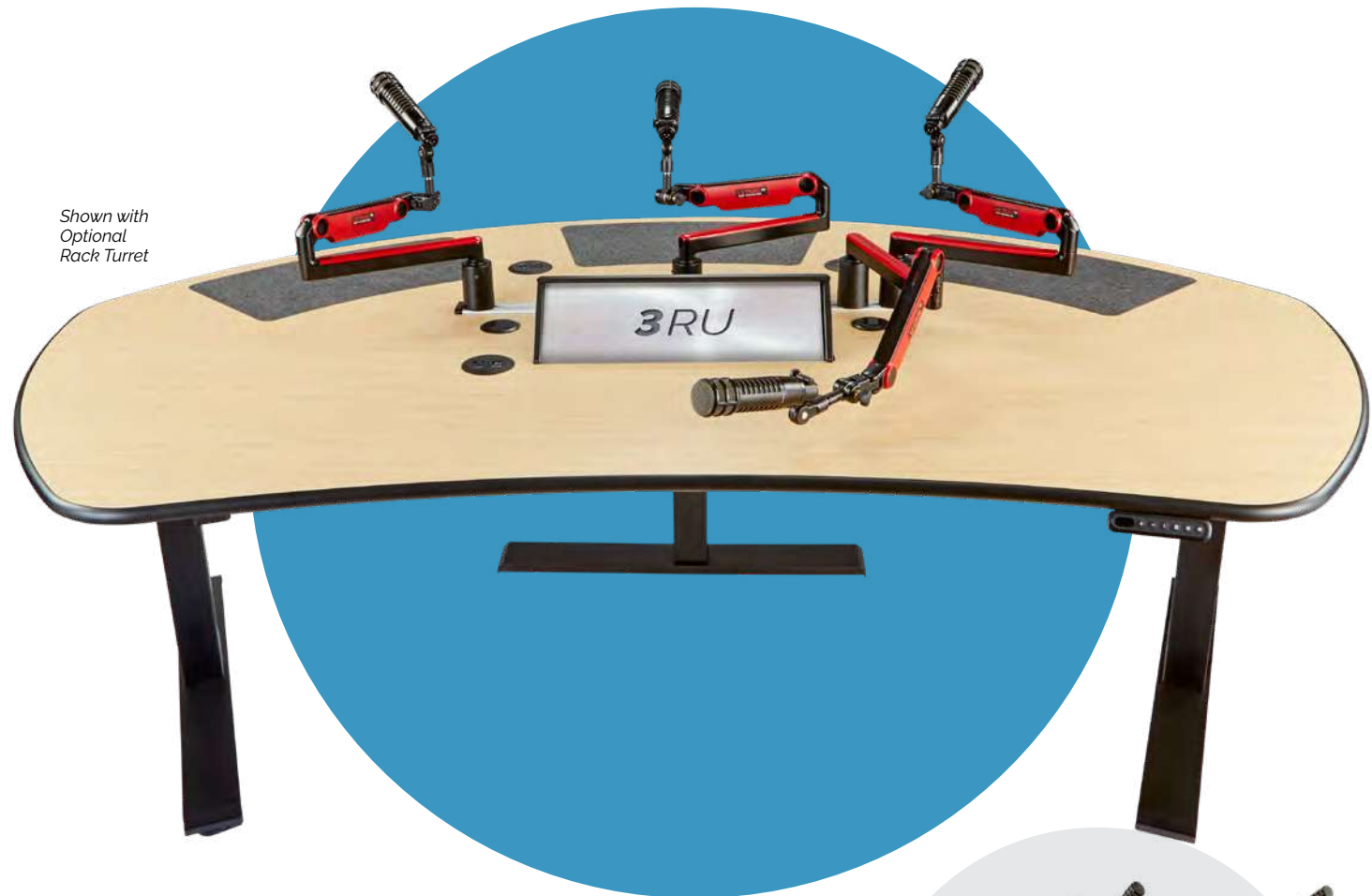
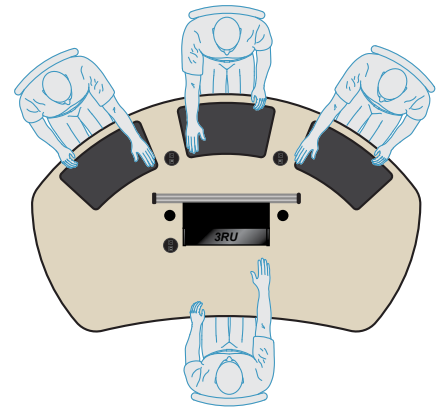

Shown with
Optional
Rack Turret

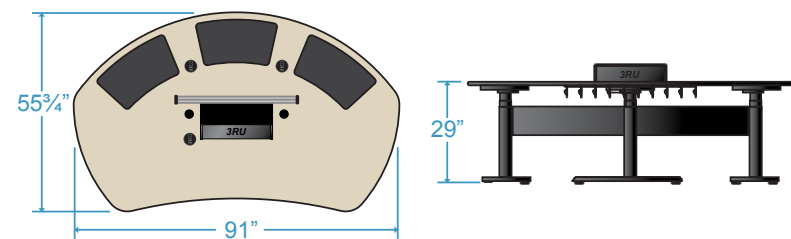

Podcast COMPARISON CHART

Find the Forecast Consoles Podcast Table that works the best for you, your space, and the people who are going to be using it.



GP-S



GP-L



FS-S



CL-S



CL-L



AH-S



AH-L



SR-S

| | 3 | 3 | 3 | 4 | 4 | 5 | 7 | 4 <small>(1 Host, 3 Guests)</small> |
|--------------------------------|--|---|--|---|--|---|------------------------------------|--|
| POSITIONS | 3 | 3 | 3 | 4 | 4 | 5 | 7 | 4 <small>(1 Host, 3 Guests)</small> |
| DIMENSIONS (L" x W") | 45½" x 47" | 59⅝" x 61¼" | 55⅝" x 59½" | 39⅜" x 39⅜" | 59½" x 59½" | 71⅝" x 46⅞" | 94" x 55" | 55¾" x 91" |
| COUNTER HEIGHT | 29" | 29" | 29" | 29" | 29" | 29½" | 29½" | 25" - 50" |
| WEIGHT (without equipment) | 90 lb | 160 lb | 160 lb | 80 lb | 160 lb | 302 lb | Contact Us | Contact Us |
| REMOVABLE FABRIC INSERTS | 3 | 3 | 3 | 4 | 4 | 3 | 3 | 3 |
| MIC ARM MOUNTING STYLE | Through | Rail | Rail | Through | Rail | Rail | Rail | Rail |
| CABLE MANAGEMENT | Undercounter | Undercounter & Cable Base | Undercounter & Cable Base | Undercounter | Undercounter & Cable Base | Undercounter & Arc Base | Undercounter & Arc Base | Undercounter & Flexible Cable Carrier |
| SIT STAND HEIGHT ADJUSTABLE | Available Option | Available Option | Available Option | Available Option | Coming Soon | No | No | Yes |
| CONVENIENCE POWER OUTLETS | 1 | 3 | 3 | 1 | 2 | 4 | 4 | 3 |
| PDU OUTLET COUNT | 8 Compact | 8 | 8 | 8 Compact | 8 | 12 | 12 | 8 |
| SHIPPING DIMENSIONS (One Skid) | 1 SKID: 64" x 17" x 64" (130 lbs) | 1 SKID: 64" x 17" x 64" (200 lb) | 1 SKID: 64" x 17" x 64" (200 lbs) | 2 BOXES: Box 1 - 24" x 12" x 9" (20 lbs) Box 2 - 42" x 42" x 6" (60 lbs) | 1 SKID: 64" x 17" x 64" (200 lbs) | 2 SKIDS: Skid 1 - 53" x 34" x 34" (158 lbs) Skid 2 - 79" x 17" x 56" (224 lbs) | Contact Us | Contact Us |

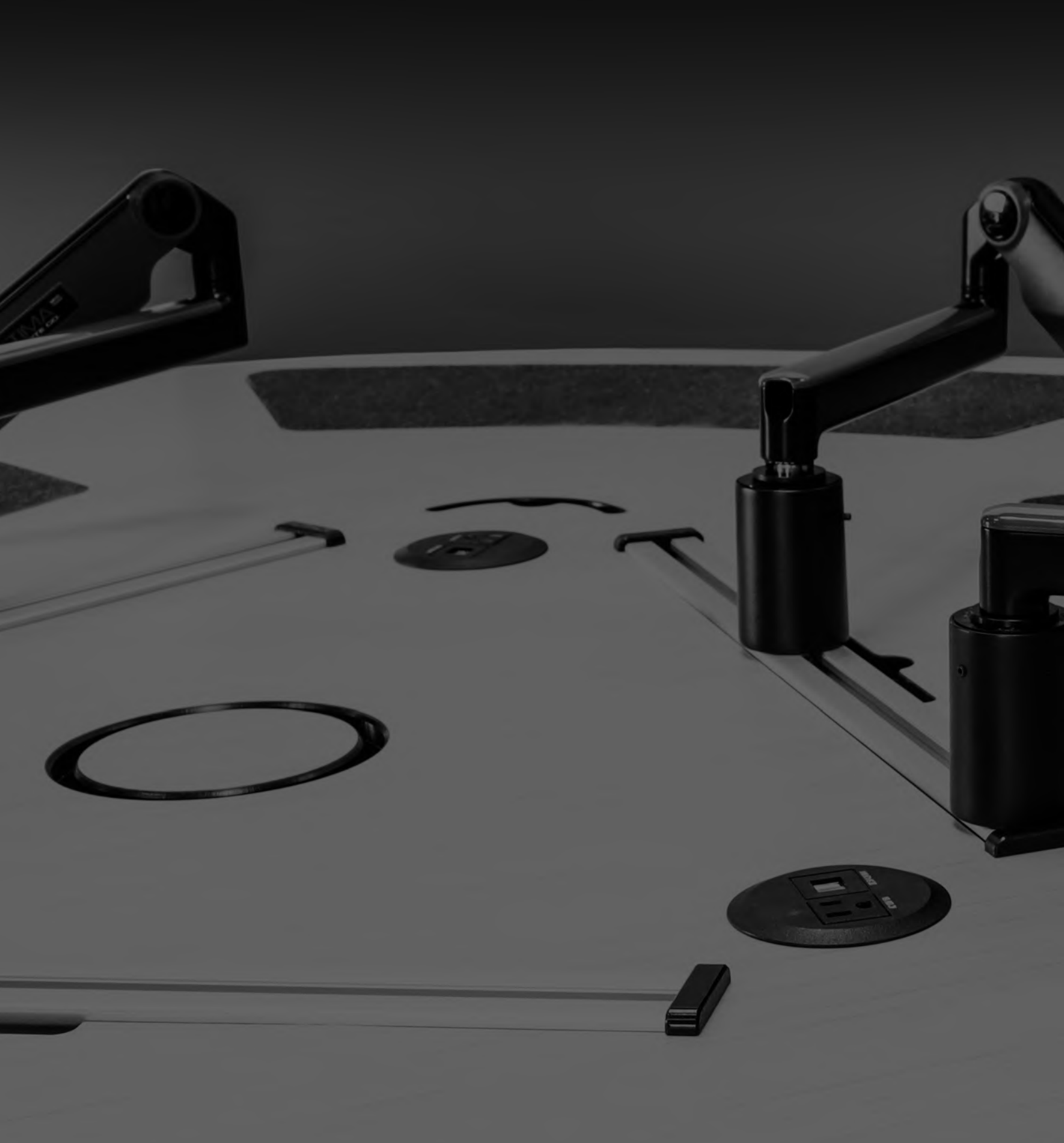

 **Forecast**
INNOVATIVE TECHNICAL FURNITURE

For more information: **(800) 735-2070** or **info@forecast-consoles.com**

All designs, plans, ideas & specifications in this drawing remain the entire property of Forecast Consoles Inc. and may not be reproduced or used in any manner without written consent.

**Prices upon request*